



Electrical Ratings Type KD1

Silver contacts	Inductive load	Resulting load
30 V =	3.0 A	5.0 A

	IMPORTANT
Data only valid for application in non-explosive atmosphere.	
We recommend to use a prefuse of the maximum current rating from the table above according to the load switched.	
As the lamp load is hardly relevant in the field we abstain from relating details. More information on request.	

Electrical Ratings Type KLK/KLM

Silver contacts	Inductive load	Resulting load	Gold plated contacts
30 V =	3.0 A	5.0 A	U_{max} 30 V =
			I_{max} 400 mA
			$(U \cdot I)_{max}$ 0.12 VA

	IMPORTANT
Data only valid for application in non-explosive atmosphere.	
We recommend to use a prefuse of the maximum current rating from the table above according to the load switched.	
We recommend gold plated contacts for all intrinsically safe and other applications with low voltage/power.	

Operating life time

Normal expected service life (expressed in the number of cycles over the full adjustment range) is appr. 1 million for KLK/KD1 the pressure switches and for the KLM approx 0.5 million. This may be extended to 2.5 million cycles for piston switches max. if only a part of the adjustment range is used (about 20%).

Switch sensor life may also be effected negatively by:

- Media not compatible with the wetted materials.
- Too high switch cycling speed or more than 60 cycles per minute.
- System cycling pressure exceeding the top of the adjustable range.
- Too high electrical ratings

The proof pressure must never be exceeded, otherwise the switch may be damaged. Careful selection of the pressure range and the electrical ratings can have a positive effect on the service life of the switch.

Switching rate: KLM: max 30/min KLK/KD1: max 60/min

Operating Instructions

Compact Pressure Switches Type KD1.../KLK.../KLM...



1	Intended Applications.....	2
2	Safety Instructions.....	2
3	Standards.....	3
4	Warranty/Guaranty.....	3
5	Transport/Storage.....	4
6	Installation/Commissioning.....	4
7	Maintenance/Cleaning.....	7
8	Technical Data.....	8

Barksdale GmbH
Dorn-Assenheimer Straße 27
D-61203 Reichelsheim

Phone: +49 (6035) 949-0
Fax: +49 (6035) 949-111 and 949-113
email: info@barksdale.de
Internet: www.barksdale.de

Art. No.: 923-0181
Index N, 26.08.2022
Specifications are subject to
changes without notice!



Intended Applications

The pressure switches are specifically applied for monitoring and controlling of operations using maximum and minimum pressures. A micro switch triggers an electrical signal when minimum or maximum pressure are reached.

DANGER
<p>The switch may only be used in the specified fields of application (see type label).</p> <p>The temperature has to be within the specified ranges, the pressure values and the electrical rating must not exceed the values specified.</p> <p>Observe also the applicable national safety instructions for assembly, commissioning and operation of the switch.</p> <p>The switch is not designed to be used as the only safety relevant element in pressurized systems according to DGR 2014/68/EU.</p> <p>Without special provisions/actions, pressure switches must not be used for pure gas or hydrogen applications.</p>

Safety Instructions

The safety instructions are intended to protect the user from dangerous situations and/or material damage.

In the operating instructions the seriousness of the potential risk is designated by the following signal words:

DANGER
<p>Refers to imminent danger to men.</p> <p>Nonobservance may result in fatal injuries.</p>

WARNING
<p>Refers to a recognizable danger.</p> <p>Nonobservance may result in fatal injuries, and destroy the equipment or plant parts.</p>

CAUTION
<p>Refers to a danger.</p> <p>Nonobservance may result in light injuries and material damage to the equipment and/or to the plant.</p>

	IMPORTANT
Refers to important information essential to the user.	

	<p>Disposal</p> <p>The equipment must be disposed of correctly in accordance with the local regulations for electric/electronic equipment.</p> <p>The equipment must not be disposed of with the household garbage!</p>
-------------------------------------------------------------------------------------	--------------------------------------------------------------------------------------------------------------------------------------------------------------------------------------------------------------------------------

Standards

The standards applied during development, manufacture and configuration are listed in the CE conformity and manufacturer's declaration.

Warranty/Guaranty

Warranty

Our scope of delivery and services is governed by the legal warranties and warranty periods.

Terms of guaranty

We guaranty for function and material of the compact pressure switch under normal operating and maintenance conditions in accordance with the statutory provisions.

Loss of guaranty

The agreed guaranty period will expire in case of:

- changes or modifications to the housing/switch/fitting
- incorrect use,
- incorrect installation or
- incorrect handling or operation contrary to the provisions of these operating instructions.

No liability is assumed for any damage resulting therefrom, or any consequential damage.

Transport/Storage

CAUTION
Severe shock and vibrations should be avoided during transport. Storage should be dry and clean.

Installation/Commissioning

DANGER
Only install or uninstall the switch when deenergized (electrically and hydraulically/pneumatically).
Pressure connection and electrical connection must be carried out by trained or instructed personnel according to state-of-the-art standards.
The switch must only be installed in systems where the maximum pressure P_{max} is not exceeded (see type label).

WARNING
Pressure peaks and pressure shocks exceeding the maximum operating pressure are inadmissible.
The maximum operating pressure is the upper final value of the adjustable range or, if specified, the pressure indicated as maximum operating pressure. Exceeding the max. operating pressure affects the performance and the life span of the product and may damage it.
Pressure switches must be mounted vibrationless.

WARNING
Check the switch regularly for functioning.
If the switch does not work properly, stop operation immediately!

 IMPORTANT
All pressure switches are tested for proper functioning before they leave the factory.
The factory proof pressures are stated on the type plate.
All pressure switches are set to a fixed set point in the factory.

Contact Protection

The micro switches used are normally suitable for both direct and alternating current operation. Inductive, capacitive and lamp loads may, however, considerably reduce the life expectancy of a micro switch and, under extreme circumstances, even damage the contacts.

Depending on the application spark suppression and current limiting is recommended (see succeeding figures).

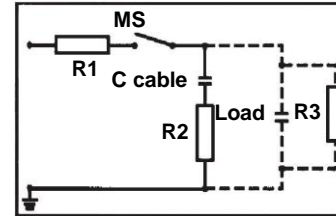

Fig. 1: Protection in case of capacitive loads R1: Protection against starting current rushes R2,R3: Protection against high discharge currents

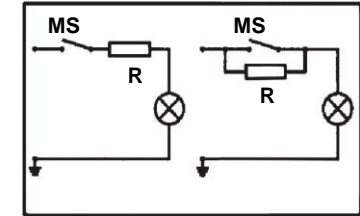

Fig. 2: Lamp load provided with resistance in parallel or series connection to switch of condensators

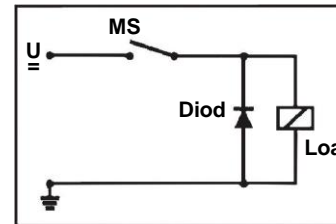

Fig. 3: Protection in case of continuous current and inductive load by recovery diode

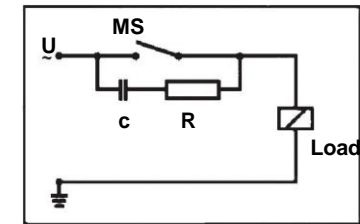



Fig. 4: Protection in case of alternating current and inductive load by RC-link

Set point adjustment

The switch contact is factory set to the customer's requirements (see type plate).

 IMPORTANT
Factory-Provided: pressure (temperature) switch point setting We confirm for pressure (temperature) switches that have been factory set the setting will be detailed on the label name plate.
Warranty is not applicable for any changes that may occur due to transportation or installation. For critical applications we recommend the setting is checked and re-set if necessary after installation and wiring of the pressure (temperature) switch.

Wiring Code for all Types (Contact status at atm. pressure)

KD1-K2

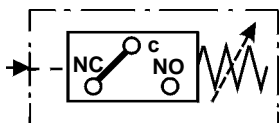

C = green
NC = white
NO = brown

KD1-A1

Normally Open NO

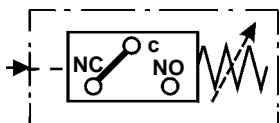

C = housing
NC = not connected
NO = spade connector 6.3 - DIN 46244

Normally Closed NC

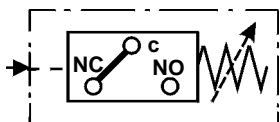

C = housing
NC = spade connector 6.3 - DIN 46244
NO = not connected

KLK/KLM

-K2

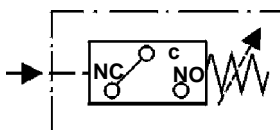

C = green
NC = white
NO = brown

-S1

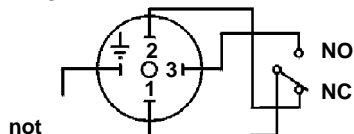

not

Fig. 5: Wiring Code

Use in Hazardous Locations

The pressure switches to be used in hazardous locations are principally designed for intrinsically safe circuits i following the applicable regulations and are provided with a blue plate bearing the words "For intrinsically safe Ex i application".

They must be operated with a switch amplifier as shown in Fig. 6. They are only for use in approved intrinsically safe circuits.

Switches with explosion-proof enclosures must be operated in accordance with their approval. Approval class and identification characteristics according to type plate information must always be observed.

EC-design approved types are marked with a type plate according to ATEX 2014/34/EU.

The wiring between switch and Ex i isolation amplifier must meet the local safety requirements.

The customer must provide for a highly conductive connection between switch and grounding.

Unprotected area

Ex ia area

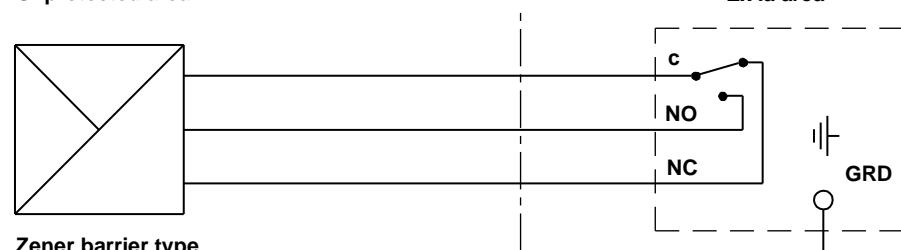

Zener barrier type
Switch amplifier NAMUR

Fig. 6: Operation of pressure switches in intrinsically safe areas

Maintenance/Cleaning

Maintenance

The pressure switch is maintenance free. Checking the set points lies within the discretion of the user. The usual preventive maintenance work in accordance with the PED and ATEX guidelines must always be carried out.

Technical Data

See data sheet

Dimensions in mm (inch)

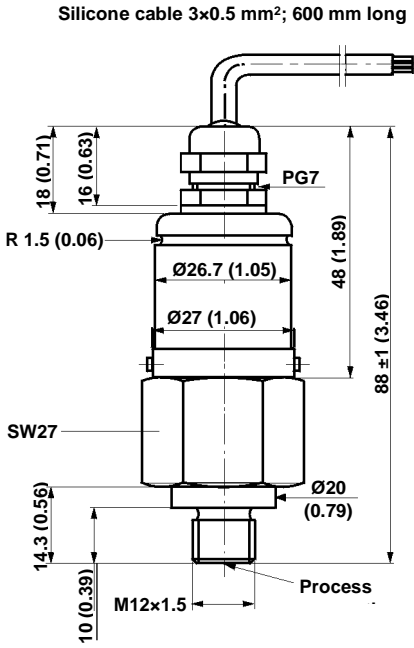

Fig. 7: Piston pressure switch type KD1-...-K2

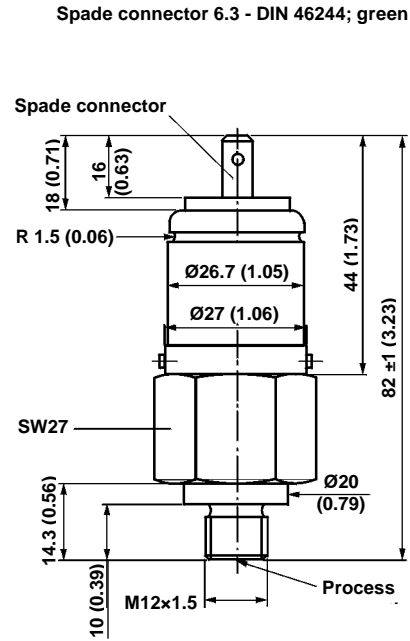

Fig. 8: Piston pressure switch type KD1-...-A1

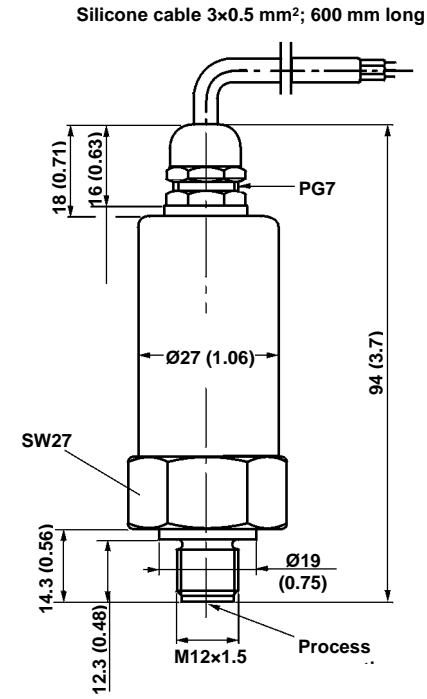

Fig. 9: Piston/diaphragm pressure switch type KLK/KLM-...-K2

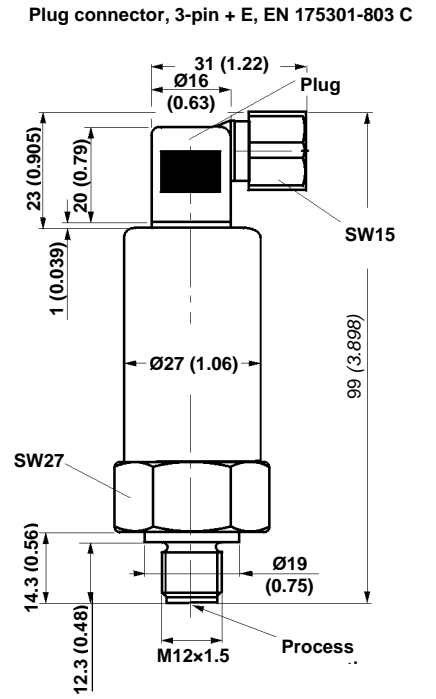



Fig. 10: Piston/diaphragm pressure switch type KLK/KLM-...-S1

Approval data for pressure switches type KLK/KLM-...-K2

Approval:  II 1 G Ex ia IIC T6 Ga
II 1 D Ex ia IIIC T₂₀₀ 100°C Da

Certificate no.: TÜV 22 ATEX 322922 X, IECEx TUN 22.0011X

Permissible ambient temperature: -40 °C ≤ Ta ≤ +75 °C

Electrical data for intrinsically safe application: U_i = 28 V li = 50 mA
Pi = 0,84 W Li, Ci = negligibly small

Standards applied: EN IEC 60079-0:2018/AC:2020-02, IEC 6079-0:2017, EN 60079-11:2012, IEC 60079-11:2011

Approval data for pressure switches type KLK/KLM-...-S1

Approval:  II 1 G Ex ia IIB T6 Ga
II 1 D Ex ia IIIC T₂₀₀ 100°C Da

Certificate no.: TÜV 22 ATEX 322922X, IECEx TUN 22.0011X

Permissible ambient temperature: -40 °C ≤ Ta ≤ +75 °C

Electrical data for intrinsically safe application: U_i = 28 V li = 50 mA
Pi = 0,84 W Li, Ci = negligibly small

Standards applied: EN IEC 60079-0:2018/AC:2020-02, IEC 6079-0:2017, EN 60079-11:2012, IEC 60079-11:2011

For devices with connected cables, an additional capacitance of 200 pF/m and an additional inductance of 1µH/m must be calculated.

 CAUTION

Special conditions for use:

- 1.The size of the nameplate exceeds the permissible area and can therefore be electrostatically charged: For IIC Ga uses the pressure switches have to be installed and used in such a way, that electrostatic charging from operation, maintenance and cleaning is excluded.
For the use in explosive dust atmospheres process-related electrostatic charges, e.g. due to passing media have to be excluded.
- 2.All metallic parts of the devices have to be included in the local potential equalization.
- 3.The intrinsically safe circuit of the device is connected to the earth potential, therefore potential equalization has to exist in the entire area of the installation of the intrinsically safe circuit.
- 4.The housings of the devices consist of more than 10% aluminum, therefore in EPL Ga applications the installation has to be carried out in such a way, that ignition hazard due to impact or friction can be excluded.

 CAUTION

No inadmissible heating can be expected that affect the maximum surface temperature. The maximum surface temperature lies only a small amount above the permissible ambient temperature during operation.

Adjustable ranges

Order code	Adjustment ranges		Max. proof pressure [bar]	Max. operating pressure [bar]	Max. hysteresis (end of range)
	Pressure				
			(short term)		
KD1 - 30/100	30...	100	450	300	16.5 19.0
KD1 - 60/300	60...	300	450	300	34.0 48.0
KLM-006	1...	6	80/200 *	40*	0.6
KLM-025	5...	25	80/200 *	40*	2.6
KLM-040	10...	40	80/200 *	40*	3.8
KLK-100	30...	100	450	300	15
KLK-300	60...	300	450	300	30
KLK-400	150...	400	600	400	60

* Higher operating pressure (up to 150 bar) (with proof pressure 200 bar) on request. Please add to your order!

Barksdale巴士德中国签约经销商: 信德迈科技(北京)有限公司

北京朝阳区望京SOHO-T1-C座2115室 邮编: 100102
手机: 139 1096 2635 电子邮件: sales@cnmec.biz